

Optan™ Flat Window

by Crystal IS

OPTAN FLAT WINDOW—UVC LEDs IN A TO-39 PACKAGE WHICH OFFERS SUPERIOR LIGHT OUTPUT, EXCELLENT SPECTRAL QUALITY AND LONG LIFETIMES. AVAILABLE IN PEAK WAVELENGTHS OF 255 nm AND 280 nm WITH OPTICAL LIGHT OUTPUT > 1 mW, THESE LEDs ARE IDEAL FOR SPECTROSCOPIC APPLICATIONS IN ANALYTICAL AND LIFE SCIENCES INSTRUMENTATION.

Features

- > WIDE RADIATION PATTERN WITH A VIEWING ANGLE OF 115°
- > AVAILABLE IN TWO PEAK WAVELENGTHS: 255 nm AND 280 nm
- > LIGHT OUTPUT GREATER THAN 1 mW
- > MAXIMUM DRIVE CURRENT OF 100 mA IN CONTINUOUS MODE
- > TYPICAL L50 LIFETIME OF 3000 HOURS AT 100 mA
- > HERMETIC, THROUGH-HOLE PACKAGE
- > RoHS COMPLIANT*

Benefits

- > FLEXIBILITY TO MODIFY EMISSION PATTERN
- > GREATER TOLERANCE IN ALIGNMENT WITH FIBER
- > NARROW SPECTRUM ENABLES ELIMINATION OF FILTERS
- > RELATIVELY LOW SYSTEM COST
- > SUPERIOR LIGHT PER UNIT WAVELENGTH (mW/nm)
- > ENVIRONMENT-ISOLATED PACKAGE



Product Nomenclature

Optan Flat Window is binned by wavelength and total optical power output.

Part Number ¹	Peak Wavelength			Optical Output at 100 mA ²	
	Min	Typical	Max	Min	Max
OPTAN-255J-FL	250 nm	255 nm	260 nm	1.0 mW	
OPTAN-280J-FL	275 nm	280 nm	285 nm	1.0 mW	

Notes:

1. LEDs are produced with semiconductor technology that is subject to process variation, yielding a range of flux performance that is approximately Gaussian in nature. To provide customers with fine granularity within the overall flux distribution, Crystal IS separates LEDs into optical power bins.
2. Output power is measured using a 100 mA current pulse of < 1s duration at an ambient temperature of 25 °C ± 5 °C with the diode inserted into an integrating sphere.

* Product applies to exemption 7(c)-I. See RoHS Compliance on the last page of this document for information on RoHS exemption 7(c)-I



LED Characteristics

Characteristic	Unit	Min.	Typical	Max.
Optical output (P_o) at 100 mA ¹	mW	1		
Viewing angle ²	degrees		115	
Full width at half maximum	nm		12	
Forward voltage at 100 mA ³	V			10
Lifetime, L50 at 100 mA	hours		3000	
Lifetime, L50 at 20 mA	hours		8000	
Thermal resistance, junction-to-case	°C/W		20	
Power dissipation	W			1.0

Notes:

- Optical output measurement tolerance is $\pm 10\%$. Optical output is measured at case temperature of $25\text{ °C} \pm 5\text{ °C}$.
- Viewing angle is twice of half-value angle. A half-value angle is the angle between axial direction and direction in which the light intensity value is half of the axial intensity.
- Voltage tolerance is $\pm 5\%$.

Absolute Maximum Ratings

	Unit	Min.	Max.
Forward current	mA		100
Reverse voltage	V		-5
Operating temperature range	°C	-10	55
Storage temperature	°C	-40	100
Junction temperature	°C		85

Typical Radiation Pattern

Optan Flat Window LEDs have a nominal viewing angle of 115°.

RADIATION PATTERN

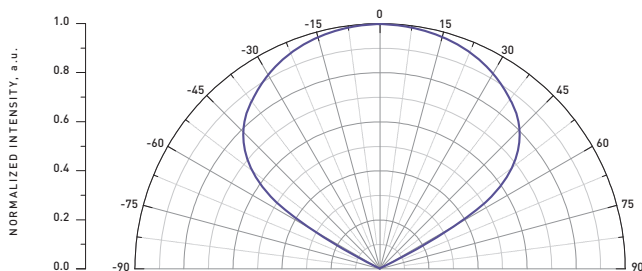

Test Conditions: $I (CW) = 100\text{ mA}$
 CW = Continuous Wave Mode

Typical Electrical Characteristics

The typical forward voltage is less than 10 V at an operating current of 100 mA.

ELECTRICAL CHARACTERISTICS

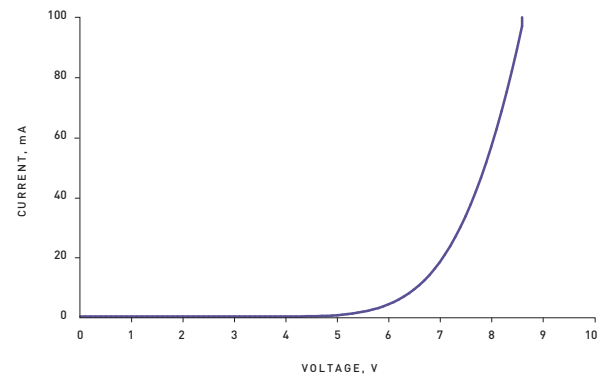

Test Conditions: $I (CW) = 1\text{ to }100\text{ mA}$; Case Temperature (T_c) = 25 °C



Typical Spectral Characteristics Over Current

The plot below shows the stability of the peak wavelength with various applied currents. No shift is typically observed in the peak wavelength with change in drive current from 100 mA to 20 mA.

SPECTRUM VS. CURRENT

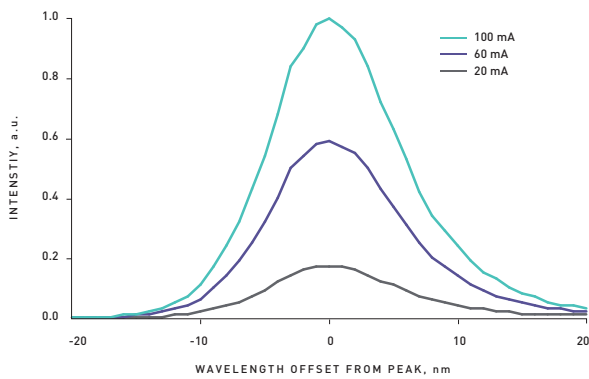

Test Conditions: Case Temperature (T_c) = 25 °C

Typical Light Output Characteristics Over Current

The plot below shows the typical variation in light output with forward current. The light output data is normalized to the light output at 100 mA.

LIGHT OUTPUT OVER CURRENT

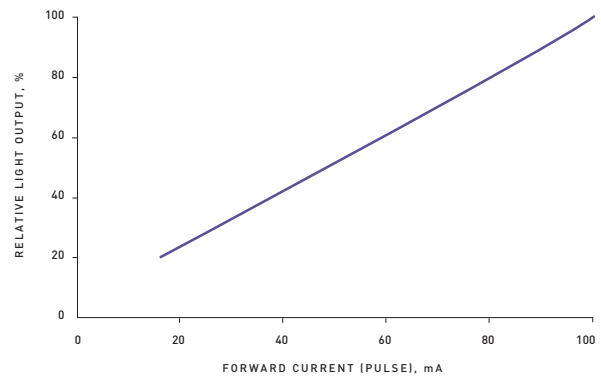

Test Conditions: Case Temperature (T_c) = 25 °C

Typical Spectral Characteristics Over Temperature

The plot below illustrates the stability of the spectral characteristics with change in temperature.

SPECTRUM VS. TEMPERATURE

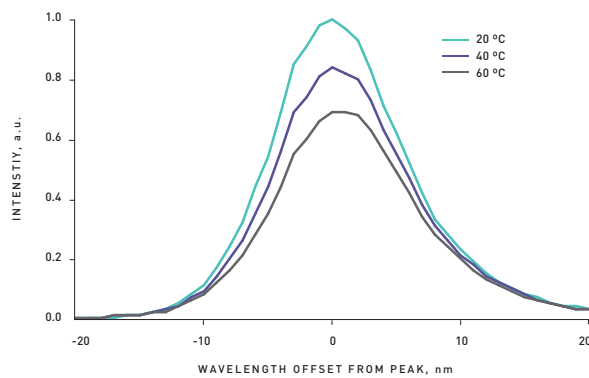

Test Conditions: I (CW) = 100 mA

Typical Light Output Characteristics Over Temperature

Output power is very sensitive to case temperature, so proper thermal management techniques are suggested to control case temperature.

LIGHT OUTPUT OVER TEMPERATURE

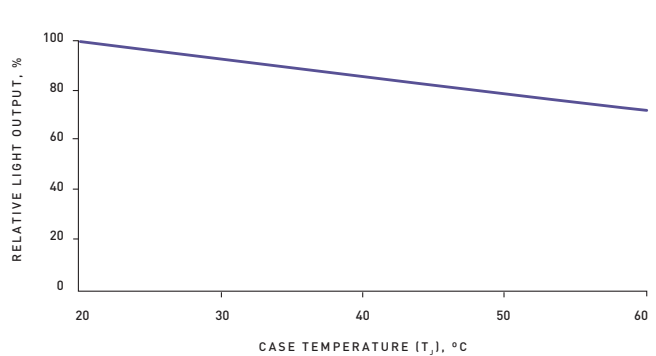

Test Conditions: I (CW) = 100 mA



Recommended Operation

Crystal IS LEDs should be operated at currents below 100 mA and mounted on a heat sink to keep the case temperature below 55 °C. Please refer to the Crystal IS thermal management note AN003 for heat sink recommendations. Circuits should be designed for constant current.

CURRENT DERATING CURVE

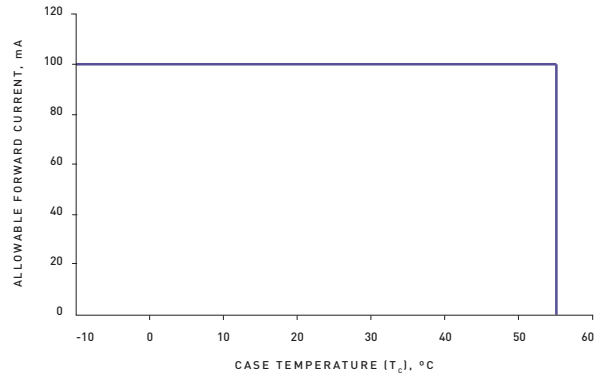

Test Conditions: CW

Mechanical Dimensions

OPTAN T0-39 PACKAGE WITH FLAT WINDOW

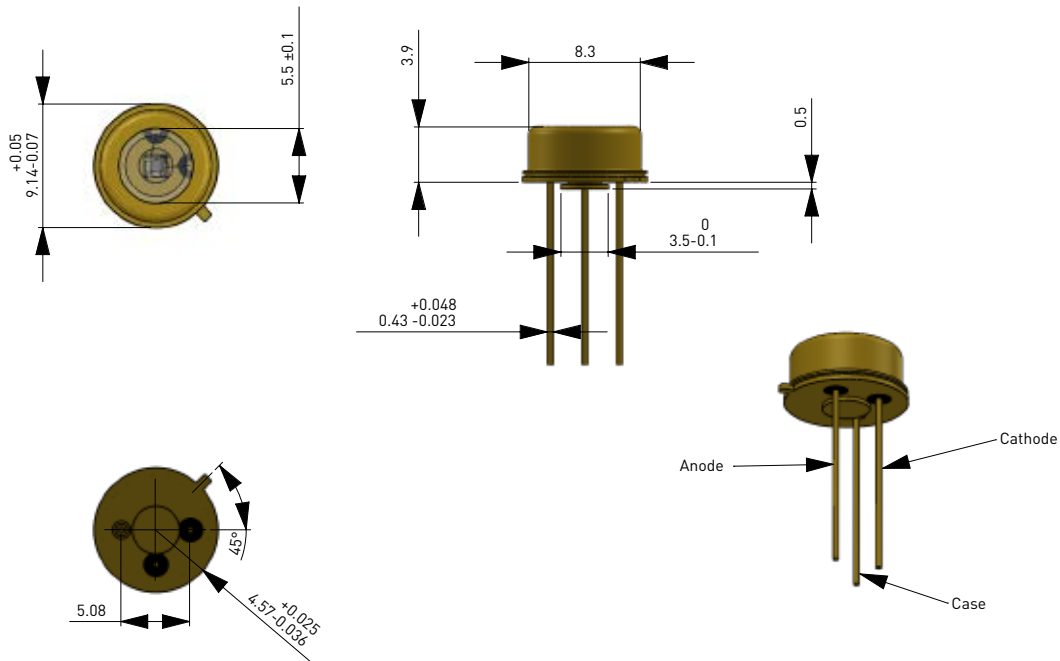

All dimensions are in millimeters. Unless noted otherwise, all dimensions have a tolerance of ± 0.05 mm.



Recommended Soldering Guidelines

1. The pitch of the LED lead should match the pitch of the mounting holes on the PCB during component placement.
2. The tip of the soldering iron should never touch the lens.
3. Recommended soldering pattern is illustrated in Figure 1. In addition, please ensure that the central copper slug in the header is thermally connected to the board with thermal paste or grease. A heat sink should be used to keep the case temperature of the LED below 55 °C at a forward current of 100 mA. Please refer to the Crystal IS thermal management note AN003 for heat sink recommendations.
4. After soldering, avoid applying external force, stress, and excessive vibration until the product has returned to ambient temperature.

Recommended Soldering Conditions

Distance between melted solder sides to bottom of LED should be 3 mm or longer.

Parameter	Dip Soldering (Lead Free Solder)	Hand Soldering (Lead Free Solder)
Pre Heat	90 °C max. (Backside of PCB)	--
Pre Heat Time	60 seconds max.	--
Temperature	260 °C max. (Solder Bath)	300 °C max. (Soldering Iron Tip)
Soldering Time	5 seconds max.	3 seconds max.

Recommended Cleaning

- > Cleaning with isopropyl alcohol is recommended. Propanol and ethyl alcohol may also be used.
- > DO NOT use ultrasonic cleaners with Crystal IS LEDs.
- > DO NOT use acetone or trichloroethylene to clean Crystal IS LEDs.

Problems with LEDs such as reduction in light output, opens, or shorts can be prevented as long as the LEDs are soldered under these conditions.

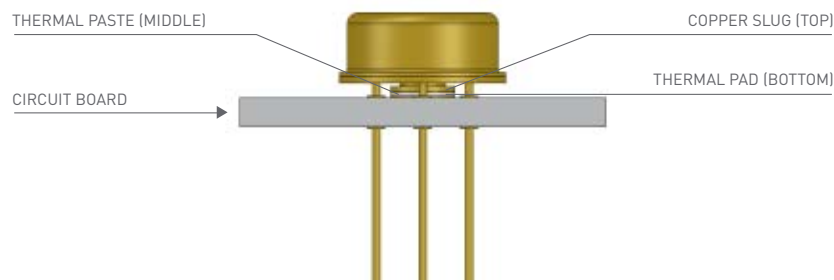

Figure 1

Eye Safety Guidelines

During operation, the LED emits high intensity ultraviolet (UV) light, which is harmful to skin and eyes. UV light is hazardous to skin and may cause cancer. Avoid exposure to UV light when LED is operational. Precautions must be taken to avoid looking directly at the UV light without the use of UV light protective glasses. Do not look directly at the front of the LED or at the LED's lens when LED is operational.

Attach the following warning labels on products/systems that use UV LEDs.



RoHS Compliance

This product complies with EU Directive 2011/65/EU on the restriction of the use of certain hazardous substances in electrical and electronic equipment (RoHS), as adopted by EU member states on January 2, 2013.

This product is compliant with EU RoHS due to an exempt use of one or more restricted substances. This product applies to the following exemption from RoHS Directives: 7(c)-I Electrical and electronic components containing lead in a glass or ceramic other than dielectric ceramic in capacitors, e.g. piezoelectronic devices, or in a glass or ceramic matrix compound.



Handling Precautions

LEDs are sensitive to static electricity. When handling, proper ESD protection is required, including:

- > Eliminating static charge
- > Using grounded wriststrap, ESD footwear, clothes, and floors
- > Grounded workstation and tools.



Disclaimer

The information in this document has been compiled from reference materials and other sources believed to be reliable, and given in good faith. No warranty, either expressed or implied, is made, however, to the accuracy and completeness of the information, nor is any responsibility assumed or implied for any loss or damage resulting from inaccuracies or omissions. Each user bears full responsibility for making their own determination as to the suitability of Crystal IS products, recommendations or advice for its own particular use. Crystal IS makes no warranty or guarantee, express or implied, as to results obtained in end-use, nor of any design incorporating its Products, recommendation or advice.

Each user must identify and perform all tests and analyses necessary to ensure that it's finished application incorporating Crystal IS' products will be safe and suitable for use under end-use conditions. Each user of devices assumes full responsibility to become educated in and to protect from harmful irradiation. Crystal IS specifically disclaims any and all liability for harm arising from buyer's use or misuse of UVC devices either in development or end-use.

We invite you to learn more about our UVC LEDs.



70 Cohoes Avenue
Green Island, NY 12183
U.S.A.

www.cisuvc.com
518.271.7375
sales@cisuvc.com