

# HazLoc Panel PC

(Intel® Haswell Platform)

## Flat Touch Panel Mount Panel PC

MODEL #: R19IHAT-66EX

Mechanical Design



### Features

- Class1, Division2 & ATEX Zone 2 Standalone device certified for hazardous area applications ([Available now](#))
- High performance / low power Intel Haswell Core i7-4650U Processor
- 19-inch 600 nits LCD panel (Optional high brightness sunlight readable 1000nits panel)
- Fanless, streamlined enclosure for highly efficient heat dissipation
- Touch screen control button to enable/disable touch screen interface
- Optical Bonding
- Optional WiFi/Bluetooth module built-in (Antenna supply by customer)



Remove the I/O Cover to reach internal I/O Ports

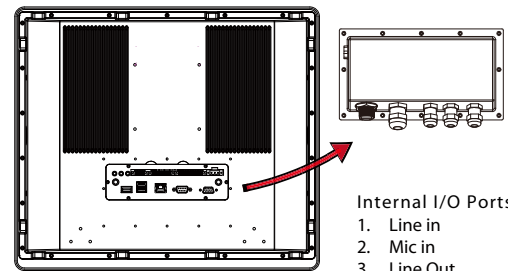

#### Internal I/O Ports:

1. Line in
2. Mic in
3. Line Out
4. USB2.0 Terminal block
5. LAN terminal block
6. RS232/422/485 Terminal block
7. 9~36V DCin Terminal block
8. USB2.0
9. USB2.0/3.0
10. RJ45 LAN
11. RS232/422/485(DB9)
12. VGA(DB15)
13. SMA for Antenna

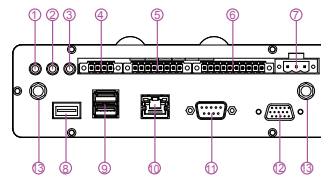

\* Note: this is a simplified drawing and some components are not marked in detail. Please contact our sales representative if you need further product information.

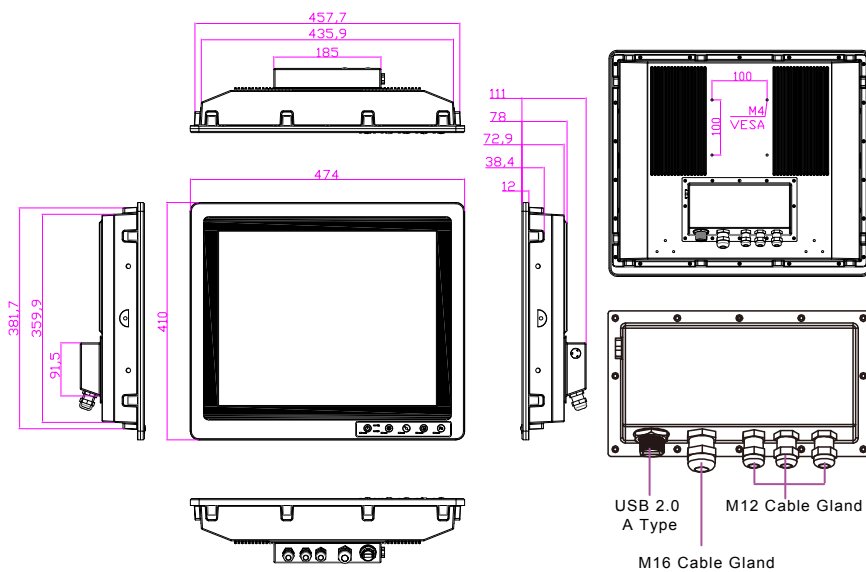

### System Specifications

#### TFT LCD Characteristics

- Resolutions : 1280 x 1024
- Brightness : 600 nits (typ.), Optional 1000 nits
- Contrast Ratio : 1000 : 1 (typ.)
- Viewing Angles : -85~85(H); -80~80(V)
- Max Colors : 16.7M
- Touch Screen : Projected Capacitive

### System Specifications

- Processor : Intel®Core i7-4650U max. 3.3GHz
- BIOS : AMI BIOS
- System Chipset : Intel®HD graphics 5000
- Memory Slot : 1 x DDR3L SO-DIMM 1600 MHz, 4GB default
- Storage : mSATA SSD 128GB
- Optional 2<sup>nd</sup> Storage: 2.5" SSD
- Wireless (Optional) : 802.11ac + BT4.0

\*Note: Customer needs to purchase ATEX-approved antennas

### Operating System (Optional)

- Windows Embedded Standard 7
- Windows 7 PRO for Embedded System
- Windows Embedded 8 Standard
- Windows Embedded 8.1 Industry Pro
- Windows 10 IoT Enterprise

### Mechanical Specification

- Cooling System : Fanless design
- Dimension(W x H x D) : 474mm x 410mm x 111mm
- Gross Weight : 13kg
- Net Weight : 13.5kg

### Power Specifications

- Power Input : 9~36V DC input (isolation)

### Environment Considerations

- Operating Temperature : -40°C to 70°C (with intelligent heater)
- Operating Humidity : 5 to 95%

### External I/O

- 1 x EX-Type Brass Cable Gland M16 (Cable range 7.5~10.2mm)
- 3 x EX-Type Brass Cable Gland M12 (Cable range 5.4~8mm)
- 1 x Non EX-Type USB 2.0 A Type

### Internal Connectors: (open the back cover to reach)

- 1 x USB 2.0 terminal block
- 1 x LAN terminal block
- 1 x RS232/422/485 terminal block
- 1 x 9~36V DC input terminal block
- 1 x USB 3.0, 2 x USB 2.0 (female type)
- 1 x RJ45 LAN
- 1 x RS232/422/485 (DB9)
- 1 x VGA (DB15)



**Standards and Certifications**

- Ordinary Location Safety : UL 60950-1  
CSA C22.2 No. 60950-1-07  
EN 60950-1
- Hazardous Location Safety : Class I, Div.2, Groups A,B,C,D T4  
-40 ≤ Tamb ≤ 70  
Meet Standards  
ANSI/ISA-12.12.01-2013  
CSA Std. C22.2 No. 213-M1987  
  
ATEX II 3G Ex nA ic IIC T4 Gc (Available now)  
-40 ≤ Tamb ≤ 70  
Meet Standards  
EN 60079-0, EN 60079-11, EN 60079-15  
  
IECEX Ex nA ic IIC T4 Gc (Available now)  
-40 ≤ Tamb ≤ 70  
Meet Standards  
IEC 60079-0, IEC 60079-11, IEC 60079-15
- CE, FCC,  
• Shock : MIL-STD-810G Method 516.6  
• Drop : MIL-STD-810G Method 516.6  
• Vibration : MIL-STD-810G Method 514.6  
• IP Rating : IP66 Meet Standard IEC60529  
(for Non-Hazardous location)  
IP54 Meet Standard IEC60079  
(for Hazardous location)

**Accessories: (for testing purpose, Non EX)**

- 24V 150W AC to DC Adapter
- Open wired power cable for M12 cable Gland
- SMA male to female extension cable for M12 cable Gland (Optional)
- Open wired LAN/COM cable for M16 cable Gland
- User's Manual
- System Recovery DVD (Optional)

## Pin Assignments

The pin assignments of the connectors are as follows:  
(Cables are supplied by customer)

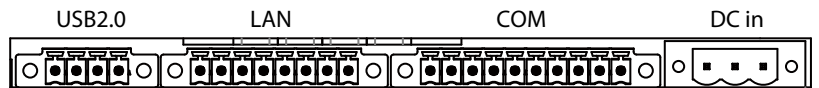

### Power terminal block

Pin	Signal Name
1	VCC+
2	VCC-
3	GND

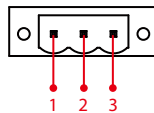

\*Power wire for VCC should be AMW 1015 18AWG 600V or above.

### COM Port

Pin	Signal Name	Pin	Signal Name
1	DCD	2	RXD
3	TXD	4	DTR
5	GND	6	DSR
7	RTS	8	CTS
9	RI	10	+V5

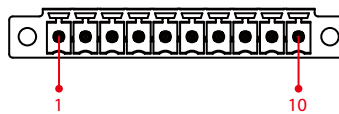

### LAN Port

Pin	Signal Name	Pin	Signal Name
1	MDIO3-	2	MDIO3+
3	MDIO2-	4	MDIO2+
5	MDIO1-	6	MDIO1+
7	MDIO0-	8	MDIO0+

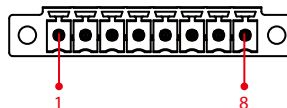

### USB Port

Pin	Signal Name
1	VCC
2	D-
3	D+
4	GND

