

Full IP65 Chassis LCD

8.4" (Stainless Design)



Specifications

Model Name	R08T200-65T1				
Viewable Size Image	8.4"				
Active Display Area(mm)	170.4 (H) x 127.8 (V)				
Pixel Pitch(mm)	0.213 (H) x 0.213 (V)				
Number of Pixels	800x600				
Contrast Ratio	600:1(typ.)				
Display Color	16.2M				
Brightness(cd/m ²)	450 (typ.)				
Viewing Angle(CR>=10)	-80~80(H);-60~80(V)				
Synchronization Range					
Horizontal/Vertical	31.5~46.9KHz / 60~75Hz				
Recommended Resolution	800x600@60Hz, 75Hz				
Signal Connector	D-Sub 15pin				
I/O	3 pin Power cable(IP65 connector); 10 pin VGA cable (IP65 connector); Optional 10 pin RS232 or USB cable(IP65 connector)				
Power Source	12V DC in, with External AC to DC Adapter (100~240V AC)				
Power Consumption	25W typical, normal operation				
Power Management	VESA DPMS Compliant				
Plug & Play	VESA DDC 1/2B				
Optional Touch Screen	Resistive				
Optional video	Yes				
Optional Optical bonding	For Moisture Prevention				
Stainless Material	CNS	JIS	ASTM	AISI	DIM
	304	SUS304	S30400	304	1.4301



Optional:
black, high polish, vanished coating

Standard:
brushed stainless

*Due to Panel material's deviation, different panel supplier will set different specific variance range to optical characteristics. The factors of time used, Lamp current, Ambient temperature will influence the optical measurements.

Mechanical Drawing

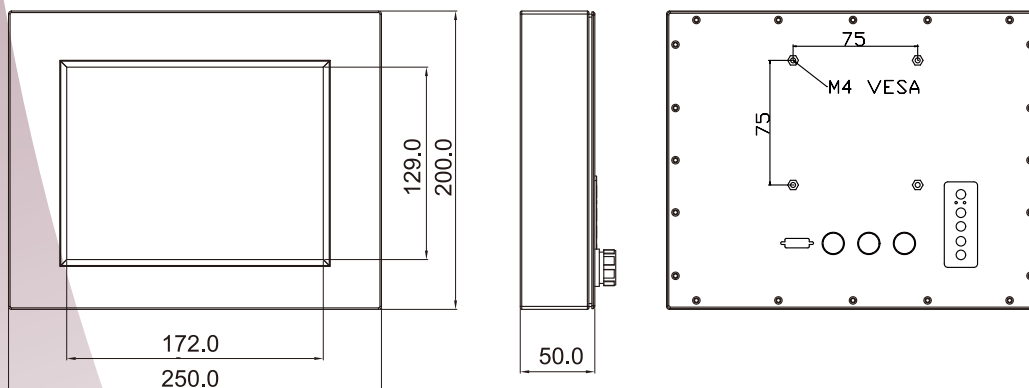

UNIT:mm

* Note: this is a simplified drawing and some components are not marked in detail. Please contact our sales representative if you need further product information.

Full IP65 Chassis LCD

IO Layout

Back Side (I/O)

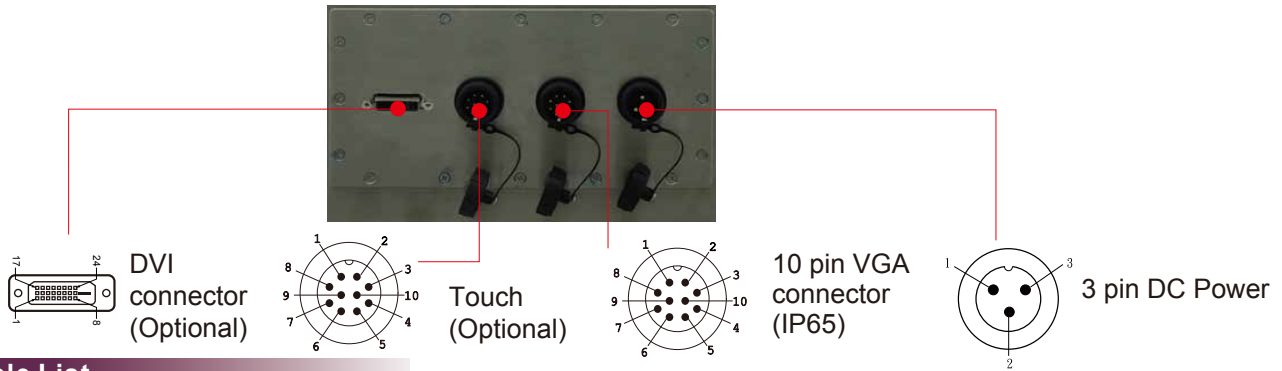

Cable List

LCD	IP65 connector	PC side IO type
DC power	3pin	Female(2.5 fai)
USB(optional)	10pin	Male(type A)
RS232(optional)	10pin	Female(D-sub 9)
VGA	10pin	Male(D-sub 15)

IP65 Cable/Pin Define

Power Cable

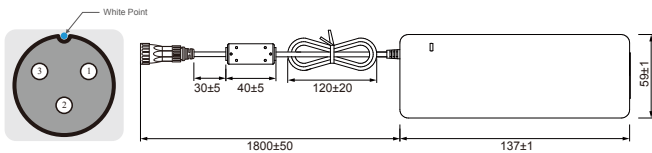

Pin No.	Symbols	Color
CN1-3	GND	Black
CN1-2	shield	
CN1-1	VCC	White

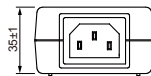

USB Cable (For Touch)

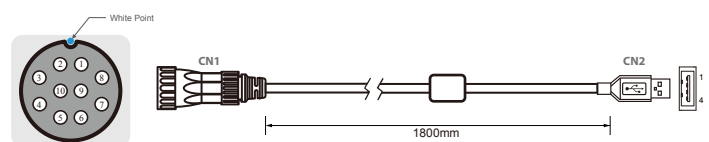

Pin No.	Symbols	Color	Pin No.	Symbols	Color
CN1-1	VCC	RED	CN2-1	VCC	RED
CN1-2	D-	WHITE	CN2-2	D-	WHITE
CN1-3	D+	GREEN	CN2-3	D+	GREEN
CN1-4	GND	BLACK	CN2-4	GND	BLACK
CN1-5	Shield		CN2-5	Shield	GREEN

Serial Cable (For Touch)

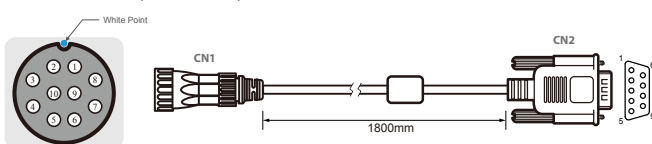

Pin No.	Symbols	Color	Pin No.	Symbols	Color
CN1-1	DCD-CON2	Green	CN2-1	DCD-CON2	Green
CN1-2	DSR-CON2	Brown	CN2-6	DSR-CON2	Brown
CN1-3	RXD-CON2	Red	CN2-2	RXD-CON2	Red
CN1-4	RTS-CON2	Orange	CN2-7	RTS-CON2	Orange
CN1-5	TXD-CON2	Blue	CN2-3	TXD-CON2	Blue
CN1-6	CTS-CON2	White	CN2-8	CTS-CON2	White
CN1-7	DTR-CON2	Purple	CN2-4	DTR-CON2	Purple
CN1-8	RI-CON2	Yellow	CN2-9	RI-CON2	Yellow
CN1-9	GND-CON2	Black	CN2-5	GND-CON2	Black
CN1-10	NC				

VGA Cable

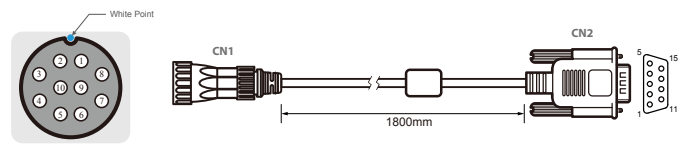

CN1				CN2		
Pin No.	Symbols	Color		Pin No.	Symbols	Color
1	R	Red	↔	1	R	Red
2	R-GIND	Black	↔	6	R-GIND	Black
3	G	Green	↔	2	G	Green
4	G-GND	Black	↔	7	G-GND	Black
5	B	Blue	↔	3	B	Blue
6	B-GND	Black	↔	8	B-GND	Black
7	SDA	Yellow	↔	12	SDA	Yellow
8	HS	Orange	↔	13	HS	Orange
9	VS	White	↔	14	VS	White
10	SCL	Brown	↔	15	SCL	Brown
				4	HS-GDN	
				5	NC	
				9	NC	
				10	NC	
				11	VS-GDN	