

Pyroelectric, Dual-Element Detectors For Intrusion Alarms

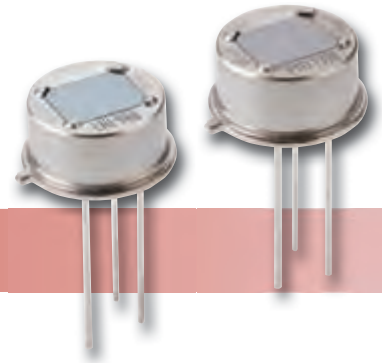

LHi 968, PYD 1398 – High-End Pyro

Applications

- Intrusion Alarms
- High-end Motion Sensors

Features and Benefits

- TO-5 metal housing
- Improved EMI protection
- Reduced (WLI)

Product Description

The analog LHi 968 series with Dual Element configuration is performance-proven top of the line product in high-end applications. The LHi 968 design provides for a reduced sensitivity to EMI and excellent White Light Immunity (WLI). PYD 1398 offers a higher level of RF immunity and is optionally available with grading for lower white light sensitivity.

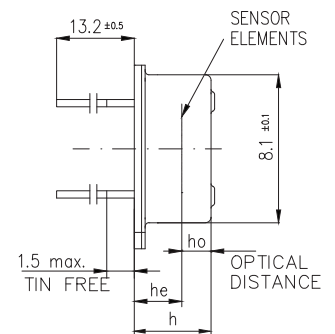
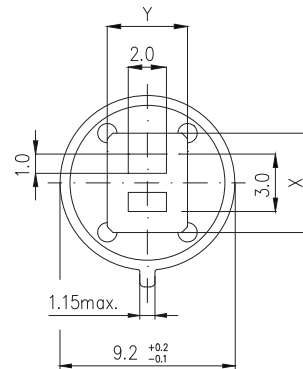
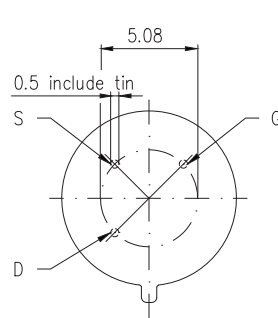
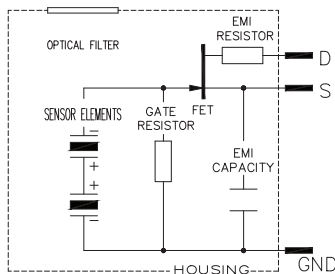

LHi 968 and PYD 1398

Parameter	Symbol	LHi 968	PYD 1398	Unit	Remarks
Responsivity, min.	R_{min}	3,3	3,3	kV/W	$f = 1 \text{ Hz}$
Responsivity, typ.	R	4	4	kV/W	$f = 1 \text{ Hz}$
Match, max.	M_{max}	10	10	%	
Noise, max.	N_{max}	50	50	μV_{pp}	0,4...10Hz/20°C
Noise, typ.	N	20	20	μV_{pp}	0,4...10Hz/20°C
spec. Detectivity	D^*	19	19	$10^7 \text{ cm}^* \sqrt{\text{Hz/W}}$	1Hz / 1Hz BW/20°C
Field of View, horizontal	FoV	100°	100°		unobstructed
Field of View, vertical		100°	100°		unobstructed
Source Voltage		0,2...1,5	0,2...1,5	V	47 kΩ, 20°C, VDD=10V
Operating Voltage		2,0...10	2,0...10	V	47 kΩ, 20°C
EMI performance		**	**		
White Light performance		**	***		Excelitas test set up
Height	h	4,2	4,2	mm	
Optical Element Location	he / ho	2,6 / 0,95	2,6 / 0,95	mm	
Filter Size	$X \times Y$	5,2 x 4,2	5,2 x 4,2	mm ²	

Pyroelectric, Four-Element Detectors For Intrusion Alarms

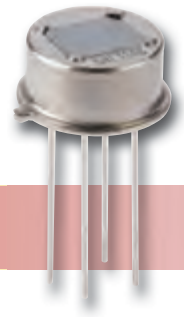

LHi 1148 – High-End, Dual-Channel Pyrodetectors

Applications

- Intrusion Alarms
- Dual-Channel Systems
- High-end Motion Sensors

Features and Benefits

- TO-5 metal housing
- Dual Channel
- Optional Reverse/Equal Polarity
- Optional Element Configurations
- RF Protection Option

Product Description

The LHi 1148 series with four element “Quad” configuration offers two independent dual element signals with opposite polarity. This enables separate signal processing option for the two channels to reduce common-mode RF influence and thermal effects.

For Ceiling-mount applications, we offer – as an option – a similar version, with dual-element pairs arranged in a diagonal geometrical arrangement and with a square-type window. This enables presence detection without any preference to direction. The series further includes various options as for element spacing and polarity arrangement. Details available on request.

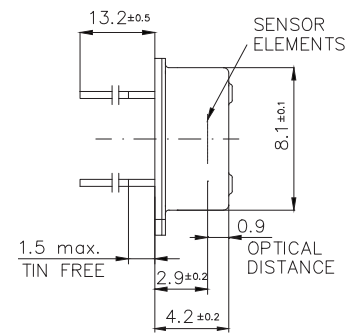
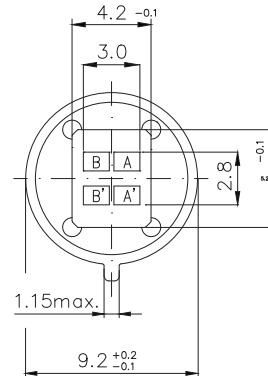
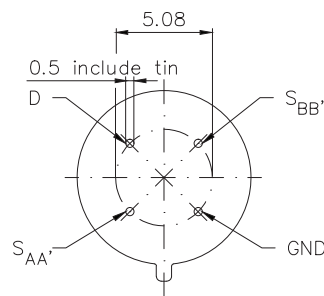
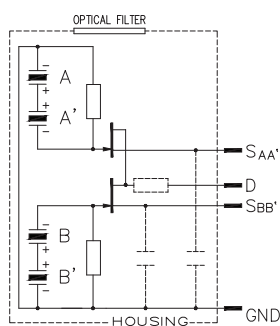

LHi 1148

Parameter	Symbol	LHi 1148	Unit	Remarks
Responsivity, min.	R_{min}	3,5	kV/W	$f = 1 \text{ Hz}$
Responsivity, typ.	R	4,5	kV/W	$f = 1 \text{ Hz}$
Match, max.	M_{max}	15	%	
Noise, max.	N_{max}	75	μV_{pp}	0,4...10Hz/20°C
Noise, typ.	N	30	μV_{pp}	0,4...10Hz/20°C
spec. Detectivity	D^*	16	$10^7 \text{ cm}^2 \cdot \sqrt{\text{Hz/W}}$	1Hz/ 1Hz BW/20°C
Field of View, horizontal	FoV	110°		unobstructed
Field of View, vertical		70°		unobstructed
Source Voltage		0,2...1,5	V	47 kΩ, 20°C, VDD=10V
Operating Voltage		2,0...10	V	47 kΩ, 20°C